



Display solution for HORECA business

VOL. 18.2 2025

# POLAR U PLATE

Arctic Environment Inspired Collection

Where to use: Buffet station | Bakery | Cafe



**Design Inspiration:** The Arctic environment, including the tumultuous ocean, snow-covered mountains, and the unique Northern Lights.

**Material Choice:** Made from durable, impact-resistant, and lightweight melamine material.

**Shape Design:** The tray edges feature a streamlined design, mimicking the shape of Arctic ice blocks, adding visual appeal.

**Versatility:** The tray is designed with versatility in mind, suitable for various occasions and needs, such as buffet areas, fresh meat refrigerators, and more.

**Environmental Concept:** The design incorporates an eco-friendly philosophy, promoting awareness and protection of the environment.

This collection of trays, inspired by the Arctic environment, integrates the beauty of nature into modern life, offering a unique visual experience for dining spaces.



# POLAR U PLATE

Arctic Environment Inspired Collection

Where to use: Buffet station | Bakery | Cafe



When diners use these trays, they can experience the unique charm of the Arctic environment, as if they were transported to that distant icy world, adding a distinctive touch of enjoyment and experience to their meal.

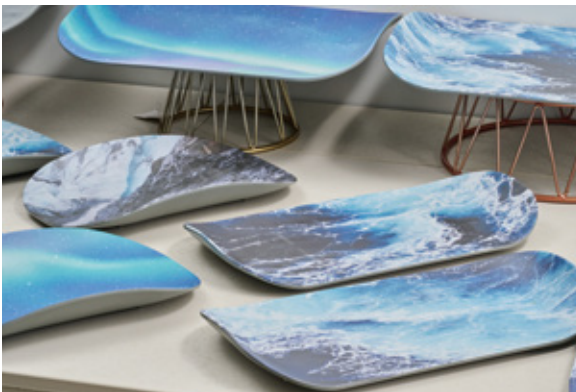

These trays are cleverly used in buffet areas, not only as containers for food but also through their unique design, creating an atmosphere of Arctic coldness and mystery.

# POLAR U PLATE

## Arctic Environment Inspired Collection

Where to use: Buffet station | Bakery | Cafe



POLAR GN 1/2 U PLATE THE SEA  
L32.5 x W26.5 x H4cm  
● 1240PCG113  
☞ 12 ☞ 24



POLAR GN 1/2 U PLATE THE LAND  
L32.5 x W26.5 x H4cm  
● 1240PCG114  
☞ 12 ☞ 24



POLAR GN 1/2 U PLATE THE SKY  
L32.5 x W26.5 x H4cm  
● 1240PCG115  
☞ 12 ☞ 24



POLAR GN 1/3 U PLATE THE SEA  
L32.5 x W17.6 x H4cm  
● 1340PCG116  
☞ 12 ☞ 24



POLAR GN 1/3 U PLATE THE LAND  
L32.5 x W17.6 x H4cm  
● 1340PCG117  
☞ 12 ☞ 24



POLAR GN 1/3 U PLATE THE SKY  
L32.5 x W17.6 x H4cm  
● 1340PCG118  
☞ 12 ☞ 24



POLAR GN 2/4 U PLATE THE SEA  
L53 x W16.2 x H4cm  
● 2440PCG122  
☞ 12 ☞ 24



POLAR GN 2/4 U PLATE THE LAND  
L53 x W16.2 x H4cm  
● 2440PCG123  
☞ 12 ☞ 24

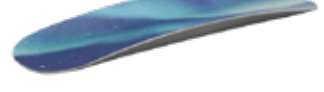

POLAR GN 2/4 U PLATE THE SKY  
L53 x W16.2 x H4cm  
● 2440PCG124  
☞ 12 ☞ 24



POLAR GN 1/4 U PLATE THE SEA  
L26.5 x W16.2 x H4cm  
● 1440PCG119  
☞ 24 ☞ 48



POLAR GN 1/4 U PLATE THE LAND  
L26.5 x W16.2 x H4cm  
● 1440PCG120  
☞ 24 ☞ 48

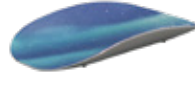

POLAR GN 1/4 U PLATE THE SKY  
L26.5 x W16.2 x H4cm  
● 1440PCG121  
☞ 24 ☞ 48

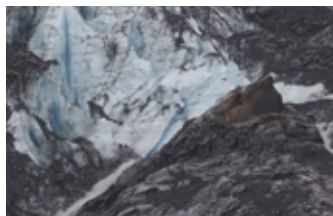

GN PAN

# POLAR U PLATE

Classic and versatile industrial or modern minimalist

Where to use: Buffet station | Bakery | Cafe



The trays feature a classic and versatile color that can complement various décor styles, offering a sophisticated and elegant look while maintaining a sense of steadiness with an industrial, modern minimalist feel.

There are also multiple shape and size options available to meet different usage needs.

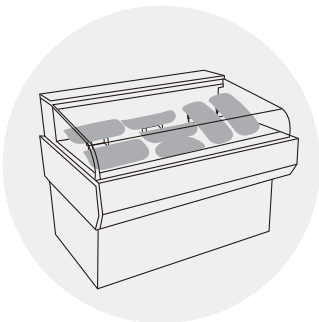

Fresh Meat Display Freezer



Special Shape Design



Used as a tray

# POLAR U PLATE

Classic and versatile industrial or modern minimalist

Where to use: Buffet station | Bakery | Cafe



POLAR GN 1/2 U PLATE BLACK  
L32.5 x W26.5 x H4cm  
● 1240PBK  
☞ 12 ☞ 24



POLAR GN 1/2 U PLATE CONCRETE GREY  
L32.5 x W26.5 x H4cm  
● 1240PCG14  
☞ 12 ☞ 24



POLAR GN 1/3 U PLATE BLACK  
L32.5 x W17.6 x H4cm  
● 1340PBK  
☞ 12 ☞ 24



POLAR GN 1/3 U PLATE CONCRETE GREY  
L32.5 x W17.6 x H4cm  
● 1340PCG14  
☞ 12 ☞ 24



POLAR GN 2/4 U PLATE BLACK  
L53 x W16.2 x H4cm  
● 2440PBK  
☞ 12 ☞ 24



POLAR GN 2/4 U PLATE CONCRETE GREY  
L53 x W16.2 x H4cm  
● 2440PCG14  
☞ 12 ☞ 24



POLAR GN 1/4 U PLATE BLACK  
L26.5 x W16.2 x H4cm  
● 1440PBK  
☞ 24 ☞ 48



POLAR GN 1/4 U PLATE CONCRETE GREY  
L26.5 x W16.2 x H4cm  
● 1440PCG14  
☞ 24 ☞ 48



GN PAN

# GAMMA - Bread station

[Hygiene solution]

A chic style Space Saving Bread Keeper with mix and match shelf

Keeping bread and food fresh can prevent the bread from becoming moist or spoiled.

Store and display bread and baked goods in a countertop bread rack made of metal .

Where to use: *Café | Bakery | Buffet bread station*

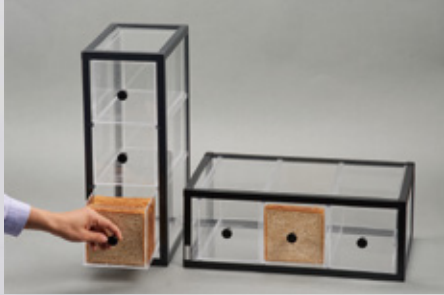



GAMMA 1/4 1 TIER BREAD CASE  
L43.5 x W26.5 x H16.2cm  
● EF01I290  
📦 1



GAMMA 1/4 3 TIER BREAD CASE  
L43.5 x W26.5 x H16.2cm  
● 904614BK  
📦 1



GAMMA 1/4 1 TIER BREAD CASE  
L43.5 x W26.5 x H32.4cm  
● EF01I291  
📦 1



MELA BOARD 7"  
L18 x W18 x H1.5cm  
● 409307ER5  
○ 409307PW9  
📦 12 📦 48



MELA BOARD 9"  
L23 x W23 x H1.5cm  
● 409309ER5  
○ 409309PW9  
📦 6 📦 36



BALLET DESSERT STAND 1.5"H  
L12.5 x W10.5 x H3cm  
● 902715BK  
📦 24



BALLET DESSERT STAND 2.5"H  
L12.5 x W10.5 x H6cm  
● 902725BK  
📦 24

### How to use :

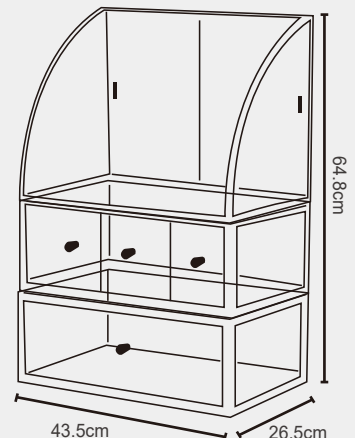
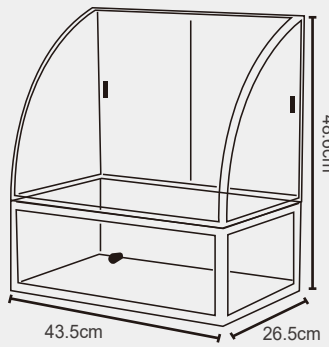
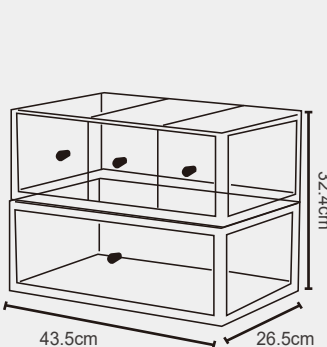

GN PAN



# GAMMA - Bread station

[Hygiene solution]

A chic style Space Saving Bread Keeper with mix and match shelf

Keeping bread and food fresh can prevent the bread from becoming moist or spoiled.

Store and display bread and baked goods in a countertop bread rack made of metal .

Where to use: *Café | Bakery | Buffet bread station*



## How to assemble :

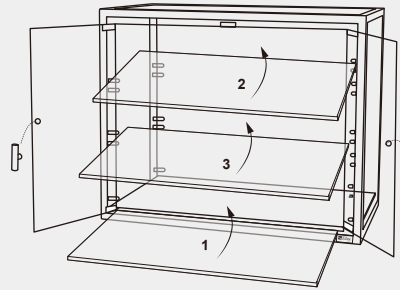

## How to use :



1: Front side flat



2: Front side tilted



3: Back side tilted

1/1



GAMMA 1/1 3 TIER PASTRY CASE \*  
L54.8 x W36.1 x H43.5cm  
● 904611BK  
📦 1

1/2



GAMMA GN 1/2 PASTRY CASE -3 TIER \*  
L34.3 x W28.3 x H43.5cm  
● 904912BK  
📦 1

GN PAN

1/3 NEW



GAMMA GN 1/3 PASTRY CASE -3 TIER \*  
L43 x W28.3 x H43.5cm  
● 904913BK  
📦 1



User friendly

\* Included 3 tiers of transparent shelf ,  
for other color board please order separately

Create your own style



# THE LAKE

Multiple accessories make your presentation a delighting fun!



1/1



1/1 GN ROLLING COVER  
L53 x W32.5 x H17cm  
● 540511TR  
📦 6

1/2 NEW



1/2 RECTANGULAR ROTATING COVER  
L34.1 x W27.8 x H17cm  
○ 541113  
📦 6

1/3



1/3 PC COVER  
L33 x W27 x H10cm  
● 540513TR  
📦 18

NEW



GN BAKER 1/1 PLATTER  
THE LAKE  
L53 x W32.5 x H1.8cm  
● 407811MLW130  
📦 3 📦 12

NEW



GN BAKER 1/2 PLATTER  
THE LAKE  
L32.5 x W26.5 x H1.8cm  
● 407812LW42  
📦 6 📦 24

NEW



GN BAKER 1/3 PLATTER  
THE LAKE  
L32.5 x W26.5 x H1.8cm  
● 407813LW41  
📦 6 📦 24

2/4



2/4 PC COVER  
L53.5 x W17.1 x H10cm  
● 540524TR  
📦 12

NEW



GN BAKER 2/4 PLATTER  
THE LAKE  
L53 x W16.2 x H1.8cm  
● 407824LW131  
📦 3 📦 12

2/8 NEW



GN BAKER 2/8 PLATTER  
THE LAKE  
L32.5 x W13.3 x H1.8cm  
● 407828LW132  
📦 6 📦 48

## How to use

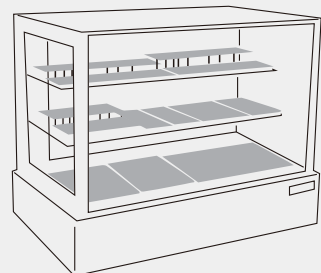
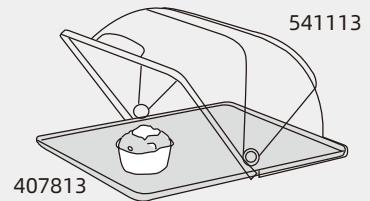

# THE LAKE

Multiple accessories make your presentation a delighting fun!



11.5" THE LAKE SALAD BOWL  
L29 x W29x H10cm  
● 226911LW133  
☞ 3 ☞ 12



16" THE LAKE SALAD BOWL  
L40 x W40 x H10cm  
● 226916LW134  
☞ 3 ☞ 12



14" THE LAKE SALAD BOWL  
L35 x W35 x H7cm  
● 227014LW135  
☞ 3 ☞ 12



16" THE LAKE SALAD BOWL  
L40 x W40 x H7cm  
● 227016LW136  
☞ 3 ☞ 12

UNI

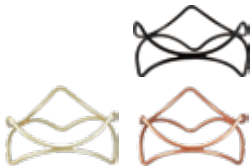

3D NON SLIP DISPLAY STAND  
DANCE 4"H  
L21.5 x W21.5 x H10cm  
● 920604GD  
● 920604RC  
● 920604BK  
☞ 6

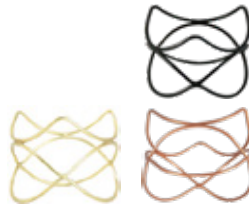

3D NON SLIP DISPLAY STAND  
DANCE 6"H  
L21.5 x W21.5 x H15cm  
● 920606GD  
● 920606RC  
● 920606BK  
☞ 6

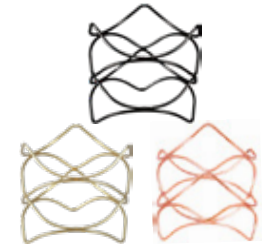

3D NON SLIP DISPLAY STAND  
DANCE 8"H  
L21.5 x W21.5 x H20cm  
● 920608GD  
● 920608RC  
● 920608BK  
☞ 6



AQUA BLUE



BUFFET DISPLAY

# DUNE

## BEST FOR SERVING YOUR FOODS:

Elegant appearance and thicker design provide good feel with sturdy material.

Designed with space saving style and smooth round edges, deep enough for snack, salad, noodle, pasta.

PERFECT FOR INDOOR AND OUTDOOR USE:

These high quality dinner plate are great for both indoor and outdoor use; practical and durable.



DUNE 9" OVAL PLATTER

L23 x W9.8 x H3.1cm

- 129309
- 129309
- 129309
- 129309BK

☞ 12 ☞ 48



DUNE 12" OVAL PLATTER

L32.1 x W13.6 x H3.1cm

- 129313
- 129313
- 129313
- 129313BK

☞ 12 ☞ 24



DUNE 8" ROUND PLATE

L20 x W19.9 x H2.3cm

- 129208
- 129208
- 129208
- 129208BK

☞ 12 ☞ 48



DUNE 9" ROUND PLATE

L23 x W29.9 x H2.3cm

- 129209
- 129209
- 129209
- 129209BK

☞ 12 ☞ 36



DUNE 10" ROUND PLATE

L26 x W26 x H2.3cm

- 129210
- 129210
- 129210
- 129210BK

☞ 12 ☞ 24

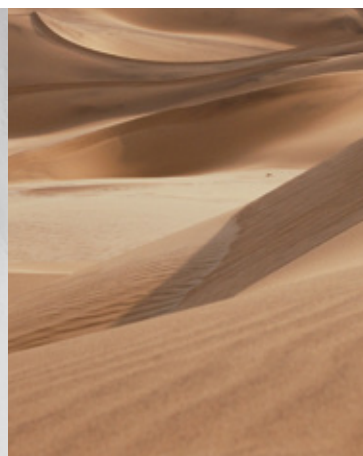



DUNE 5" RICE BOWL  
L12.6 x W12 x H5.3cm  
● 204205  
● 204205  
● 204205  
● 204205BK  
☞ 12 ☞ 72



DUNE 6" RICE BOWL  
L15 x W14.2 x H6.1cm  
● 204206  
● 204206BC  
● 204206CG  
● 204206BK  
☞ 12 ☞ 48



DUNE 9" SALAD BOWL  
L23.3 x W23 x H8.6cm  
● 204309  
● 204309  
● 204309  
● 204309BK  
☞ 6 ☞ 12



DUNE 10" SALAD BOWL  
L25 x W24.7 x H9.3cm  
● 204310  
● 204310  
● 204310  
● 204310BK  
☞ 6 ☞ 12

UNI



3D NON SLIP DISPLAY STAND  
STAR 3"H  
L13.5 x W10 x H7.3cm  
● 902603BK  
☞ 12



3D NON SLIP DISPLAY STAND  
STAR 5"H  
L13.8 x W10 x H12.7cm  
● 902605BK  
☞ 12



# LUX ISO PASTRY CASE

[Pastry display value add solution]

An elegant jewelry pastry case is great for display all dessert and pastry at the counter .

Perfect match with ISO bakery size's tray and crystal board .

Where to use: *Café | Bakery | Buffet bread station*



## How to assemble :

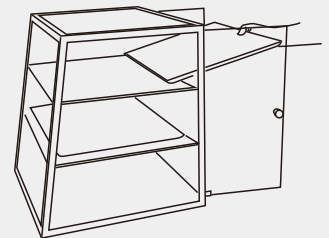
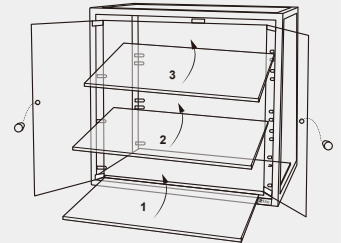

## How to use



1 x 8



2 x 4



3 x 2 2 x 1



4 x 2



4 x 1 3 x 1 1 x 1



3 x 1 2 x 1 1 x 3



5 x 1 2 x 1

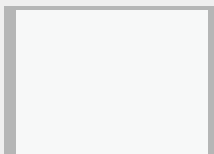

6 x 1

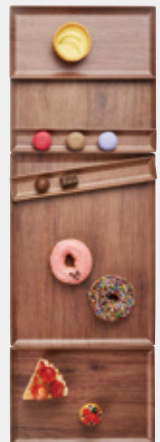



LUX ISO PASTRY DISPLAY CASE \*  
 L44.9 x W47.6 x H43.5cm  
 ● EF011292  
 ☞ 1

## Create your own style

\*Please order boards & trays separately

1



WOODY BAKER PLATTER  
 L30 x W5 x H1.8cm  
 ● 407212ER5  
 ☞ 24 ☞ 192

2



WOODY BAKER PLATTER  
 L30 x W10 x H1.8cm  
 ● 407312LW18  
 ● 407312ER5  
 ● 407312BK  
 ☞ 24 ☞ 96

3

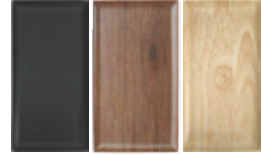

WOODY BAKER PLATTER  
 L30 x W15 x H1.8cm  
 ● 407412LW18  
 ● 407412ER5  
 ● 407412BK  
 ☞ 12 ☞ 48

4



WOODY BAKER PLATTER  
 L30 x W20 x H1.8cm  
 ● 407512LW18  
 ● 407512ER5  
 ● 407512BK  
 ☞ 12 ☞ 48

5



WOODY BAKER PLATTER  
 L30 x W30 x H1.8cm  
 ● 407612ER5  
 ☞ 6 ☞ 24

6



WOODY BAKER PLATTER  
 L30 x W40 x H1.8cm  
 ● 407716LW18  
 ● 407716ER5  
 ● 407716BK  
 ☞ 6 ☞ 24



# MOOD JOURNEY

[Eye catching solution]

All pastry and dessert deserved a nice display

to show up How delicious are they .

Make sure well cover all the room temperature pastry .

Where to use: Register area | Counter service | Pastry case area



## Monday

Let's say goodbye to Monday blue



12" ROUND SERVING TARY INDIGO BLUE  
L30 x W30 x H4cm

● 412812NB

☞ 6 ☞ 24



MJ 16" RECTANGULAR SERVING TRAY INDIGO BLUE  
L40 x W30 x H4cm

● 412816NB

☞ 4 ☞ 16

## Tuesday

Gentle reminder that the week is still young, energy boost



MJ 12" ROUND SERVING TARY PASSION RED  
L30 x W30 x H4cm

● 412812NR

☞ 6 ☞ 24



MJ 16" RECTANGULAR SERVING TRAY PASSION RED  
L40 x W30 x H4cm

● 412816NR

☞ 4 ☞ 16

## Wednesday

Going through lemon bittersweet in mid week...



12" ROUND SERVING TARY BRIGHT YELLOW  
L30 x W30 x H4cm

● 412812BY

☞ 6 ☞ 24



MJ 16" RECTANGULAR SERVING TRAY BRIGHT YELLOW  
L40 x W30 x H4cm

● 412816BY

☞ 4 ☞ 16

## Thursday

Whispers of weekend, gentle nudge to wrap up



12" ROUND SERVING TARY LIME GREEN  
L30 x W30 x H4cm

● 412812IG

☞ 6 ☞ 24



MJ 16" RECTANGULAR SERVING TRAY LIME GREEN  
L40 x W30 x H4cm

● 412816IG

☞ 4 ☞ 16

## Friday

Rolling into Weekend!



12" ROUND SERVING TRAY CHIC PINK  
L30 x W30 x H4cm  
● 412812HP  
☞ 6 ☞ 24



MJ 16" RETANGULAR SERVING TRAY CHIC PINK  
L40 x W30 x H4cm  
● 412816HP  
☞ 4 ☞ 16

## Saturday

Saturday dances in the sunlight warmth and welcoming



12" ROUND SERVING TRAY AMBER ORANGE  
L30 x W30 x H4cm  
● 412812AO  
☞ 6 ☞ 24



MJ 16" RETANGULAR SERVING TRAY AMBER ORANGE  
L40 x W30 x H4cm  
● 412816AO  
☞ 4 ☞ 16

## Sunday

Wraps us in a warm embrace, a gentle pause



12" ROUND SERVING TRAY LUSH PURPLE  
L30 x W30 x H4cm  
● 412812LP  
☞ 6 ☞ 24



MJ 16" RETANGULAR SERVING TRAY LUSH PURPLE  
L40 x W30 x H4cm  
● 412816LP  
☞ 4 ☞ 16



# BAKESTRA PASTRY TRAY

[Eye catching solution]

All pastry and dessert deserved a nice display to show up How delicious are they.

Make sure well cover all the room temperature pastry.

Where to use: Register area | Counter service | Pastry case area



The tableware collection, inspired by the symphony, is a brilliant fusion of cross-disciplinary art. It not only views tableware as a tool for everyday dining but also as a flowing musical composition on the dining table, creating a dual feast for both the senses of taste and sight.

The collection is based on the harmonious resonance of the various instruments in a symphony orchestra. Each piece of tableware is endowed with its own unique "tone" and "role," collectively performing a symphony of food and aesthetics on the table. From solos to ensembles, every piece of tableware carries an ultimate pursuit of detail and a profound understanding of beauty.





**VIOLIN 8" SQ SWEET TRAY**  
L20x W20 x H2cm  
● 414208HG106  
○ 414208IV  
☞ 12 ☞ 24



**VIOLA 10" SQ PASTRY TRAY**  
L25 x W25 x H2cm  
● 414210HG107  
○ 414210IV  
☞ 12 ☞ 24



**VIOLA 12" SQ PASTRY TRAY**  
L30 x W30 x H2cm  
● 414212HG108  
○ 414212IV  
☞ 12 ☞ 24



**CELLO 12" REC BREAD TRAY**  
L31.6 x W18 x H2cm  
● 414407HG109  
○ 414407IV  
☞ 12 ☞ 24



**VIOLA 12" REC PASTRY TRAY**  
L31.6 x W12.5 x H2cm  
● 414405HG110  
○ 414405IV  
☞ 24 ☞ 48



**CELLO 14" REC BREAD TRAY**  
L35.5x W15.5 x H4cm  
● 414406HG112  
○ 414406IV  
☞ 24 ☞ 48



**VIOLIN 10" REC SWEET TRAY**  
L25 x W16 x H2cm  
● 414110HG102  
○ 414110IV  
☞ 12 ☞ 24



**VIOLIN 11" REC SWEET TRAY**  
L29 x W16 x H2cm  
● 414111HG103  
○ 414111IV  
☞ 12 ☞ 24



**VIOLA 12" REC PASTRY TRAY**  
L30 x W20 x H2cm  
● 414112HG104  
○ 414112IV  
☞ 12 ☞ 24



**VIOLIN 13" REC SWEET TRAY**  
L34.2 x W20 x H2cm  
● 414114HG105  
○ 414114IV  
☞ 12 ☞ 24



**CELLO 14" REC BREAD TRAY**  
L35.5 x W23.5 x H2cm  
● 414409HG111  
○ 414409IV  
☞ 24 ☞ 48



**CELLO 16" REC BREAD TRAY**  
L40.5x W30 x H2cm  
● 414116HG101  
○ 414116IV  
☞ 12 ☞ 24



Realistic Pine Wood Grain



Used as a tray



Modular

# DOUBLE BASS

[Eye catching solution]

All pastry and dessert deserved a nice display to show up How delicious are they .

Make sure well cover all the room temperature pastry .

Where to use: Register area | Counter service | Pastry case area

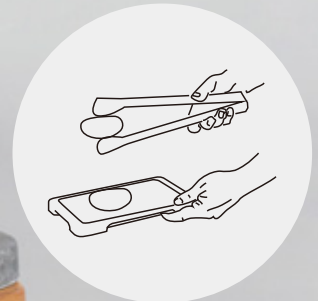

Use friendly



6" FOOD TONG TRANSPERANT  
L16 x W5.4 x H3.1cm  
○ 514106TR  
☐ N/A ☐ 288



DOUBLE BASS 11" REC  
SERVING TRAY PINE WOOD  
L29 x W16 x H2.2cm  
● 413711HG126  
☐ 12 ☐ 24



DOUBLE BASS 13" REC  
SERVING TRAY PINE WOOD  
L34.2 x W18 x H2.2cm  
● 413713HG127  
☐ 6 ☐ 12



DOUBLE BASS 14" REC  
SERVING TRAY PINE WOOD  
L37 x W26 x H2.2cm  
● 413715HG128  
☐ 6 ☐ 12



DOUBLE BASS 11" REC  
SERVING TRAY CONCRETE GREY  
L29 x W16 x H2.2cm  
● 413711CG14  
☐ 12 ☐ 24



DOUBLE BASS 13" REC  
SERVING TRAY CONCRETE GREY  
L34.2 x W18 x H2.2cm  
● 413713HCG14  
☐ 6 ☐ 12



DOUBLE BASS 14" REC  
SERVING TRAY CONCRETE GREY  
L37 x W26 x H2.2cm  
● 413715CG14  
☐ 6 ☐ 12



DOUBLE BASS 11" REC  
SERVING TRAY IVORY  
L29 x W16 x H2.2cm  
○ 413711IV  
☐ 12 ☐ 24



DOUBLE BASS 13" REC  
SERVING TRAY IVORY  
L34.2 x W18 x H2.2cm  
○ 413713IV  
☐ 6 ☐ 12



DOUBLE BASS 14" REC  
SERVING TRAY IVORY  
L37 x W26 x H2.2cm  
○ 413715IV  
☐ 6 ☐ 12

# STAND

[Eye catching solution]

All pastry and dessert deserved a nice display to show up How delicious are they .

Make sure well cover all the room temperature pastry .

Where to use: Register area | Counter service | Pastry case area



CAFÉ & COUNTER SERVICE



Match SIGNAGE



STAND  
L20 x W31.2 x H16.2cm  
● EF01281  
☐ 1 ☐ 4



STAND  
L20 x W21.2 x H32.4cm  
● EF01282  
☐ 1 ☐ 2

# SARAH COVER

Cover all your needs!

- New transportation choice
- Reversible use as an holder



6.5" NEW



SARAH 6.5" DOME COVER  
L16.5 x W16.5 x H16.6cm  
○ 531965  
☞ 54

8"



SARAH 8" DOME COVER  
L21 x W21 x H17.5cm  
○ 531908  
☞ 24

10"



SARAH 10" DOME COVER  
L26 x W26 x H20cm  
○ 531910  
☞ N/A ☞ 8



MELA BOARD 7"  
L18 x W18 x H1.5cm  
● 409307ER5  
○ 409307PW9  
☞ 12 ☞ 48



TAIJI 10" PLATTER  
L24 x W24 x H3.4cm  
● 412010IVBL  
● 412010IVBK  
☞ 4 ☞ 24



TAIJI 12" PLATTER  
L29.5 x W29.5 x H3.4cm  
● 412012IVBL  
● 412012IVBK  
☞ 3 ☞ 12

12"



SARAH 12" DOME COVER  
L31 x W31 x H23.5cm  
○ 531912  
☞ 8

14" NEW



SARAH 14" DOME COVER  
L36.3 x W36.3 x H25.3cm  
○ 531914  
☞ 1

18" NEW



SARAH 18" DOME COVER  
L45.8 x W45.8 x H29.5cm  
○ 531918  
☞ 1



MELA BOARD 13" OAK  
L32.5 x W32.5 x H1.5cm  
● 406613ER5  
☞ 6 ☞ 24

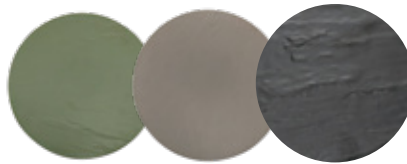

TAROKO GRANITE SLATE 17" PLATTER  
L43 x W43 x H0.7cm  
● 109917OL  
● 109917ER  
● 109917BK1  
☞ 3 ☞ 6



MELA BOARD 22"  
L56 x W56 x H2cm  
● 409322ER5  
○ 409322PW9  
☞ 3 ☞ 6

# SARAH COVER

Cover all your needs!

- New transportation choice
- Reversible use as an holder



8" NEW



SARAH 8" SQ DOME COVER  
L20.9 x W20.9 x H18.4cm  
○ 541708  
📦 12



MELA BOARD 9"  
L23 x W23 x H1.5cm  
● 409309ER5  
○ 409309PW9  
📦 6 📦 36

12" NEW



SARAH 12" SQ DOME COVER  
L31.2 x W31.2 x H25cm  
○ 541712  
📦 8



MELA BOARD 13"OAK  
L32.5 x W32.5 x H1.5cm  
● 406613ER5  
📦 6 📦 24

CAFÉ & COUNTER SERVICE



10" NEW



SARAH 10" REC DOME COVER  
L25 x W18 x H13.7cm  
○ 541610  
📦 12

15" NEW



SARAH 15" REC DOME COVER  
L37.4 x W26.8 x H19.2cm  
○ 541614  
📦 6



11" RECT TRAY  
L29 x W20 x H2cm  
○ 404011IV  
○ 404011PW9  
● 404011BK11  
📦 12 📦 48



15" RECT TRAY  
L39.5 x W28.5 x H2cm  
○ 404015IV  
○ 404015PW9  
● 404015BK  
● 404015BK11  
📦 6 📦 12



